

## WV 2 Plus

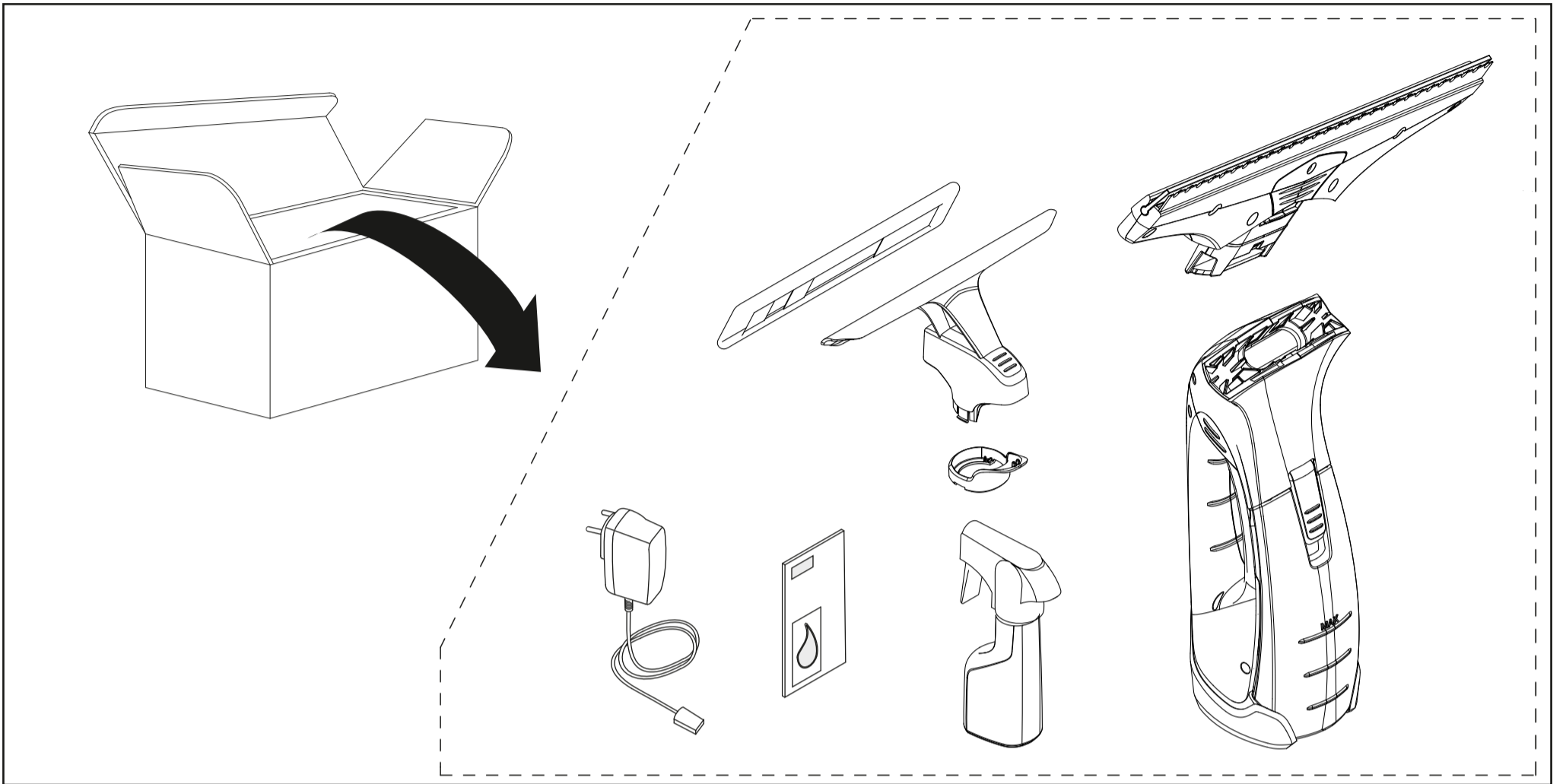

|   |                 |  |          |   |         |
|---|-----------------|--|----------|---|---------|
| <br>Li-Ion | 3,7 V           |  | IPX4     |  | 0,6 kg  |
| <br>nom    | 10 W            |  | 100 ml   |  | 120 min |
|            | V 5,5<br>mA 600 |  | 50 db(A) |  | 25 min  |

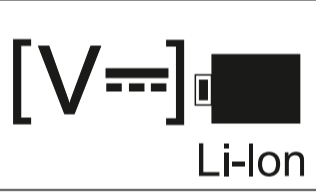
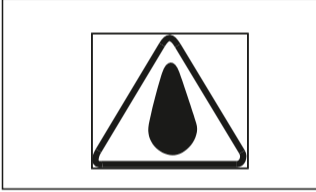
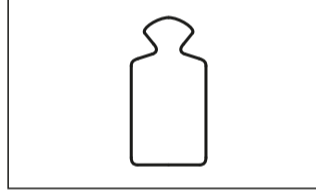
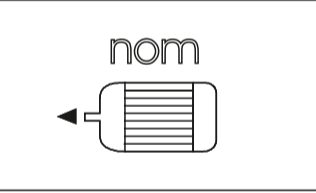
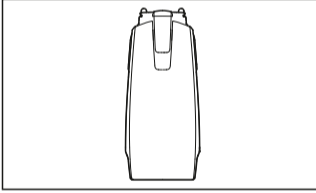
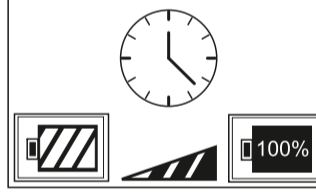
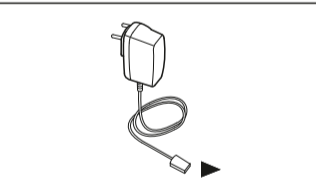
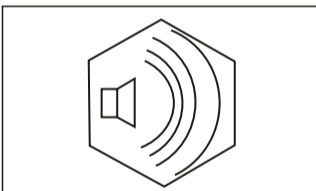
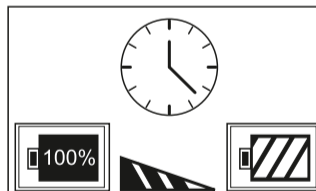